

LEE BROOM

CRESCENT LIGHT

US: CRE0110

CONTENTS

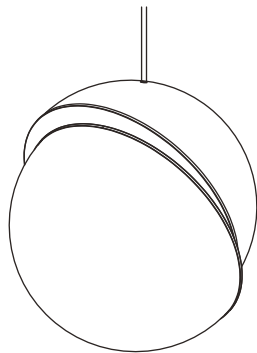

1 x Crescent Shade

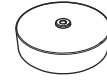

1 x Canopy



3 x Wire Nuts



1 x Allen Key



1 x LED Bulb

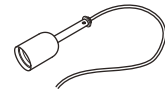

1 x Pendant Set

ATTENTION! BEFORE YOU START

For safety please read these instructions carefully before you commence install and retain them for future reference.

- Crescent must be installed by a qualified electrician.
- Install according to latest NEC wiring regulations.
- Ensure mains power supply is disconnected prior to installation.
- This product is for interior use only and should be installed in a dry environment only.
- Bulb is supplied.
- When switched on Crescent may become hot.

TECHNICAL

110-130V ~ 60Hz; E26 MAX 25W LED



For more information, please contact:

US & Canada Inquiries: +1 212 804 8477 - sales@leebroom.com

UK & Global Inquiries: +44 207 820 0742 - info@leebroom.com

BULB REPLACEMENT

- Visit www.leebroom.com to purchase recommended replacement.
- Maximum wattage E26 25W LED, 110-130V.
- Ensure Crescent is switched off & cooled down before handling.
- To replace bulb:
 - To access the old bulb repeat assembly steps 1-2.
 - Unscrew and remove the old bulb.
 - To fit replacement bulb, repeat assembly steps 5-7.

RECYCLING ELECTRICAL PRODUCTS

Lee Broom encourages all customers to notice this symbol  and avoid putting any waste electrical goods in domestic waste bins or containers. Please ensure waste electrical goods are disposed of at a suitable facility.

CARE AND CLEANING

- Only clean when Crescent is switched off.
- Please allow a suitable cooling period before cleaning.
- Only use a non-abrasive, soft, dry cloth when cleaning Crescent.

ASSEMBLY

DISCONNECT ALL MAINS POWER SUPPLY WIRES BEFORE INSTALLATION.

1. _____

Unscrew and remove the grub screw from the side of the Crescent shade. Use the allen key supplied. Ensure to retain the grub screw for reassembly.

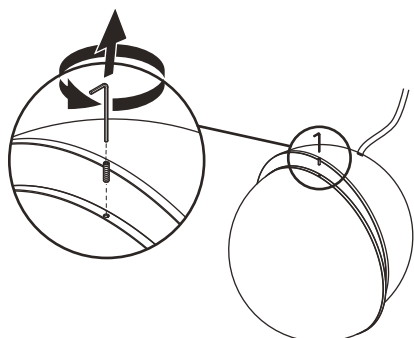

2. _____

- Separate the Crescent shade by first sliding up the lower half flush with the top half.
- Pull the two halves apart.

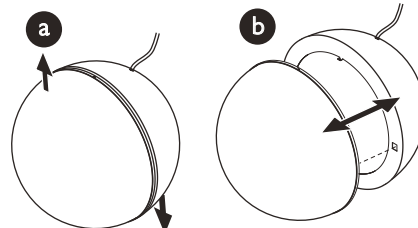

3. _____

Unscrew the end nut from the pendant set and slide over and away from the electrical cord to remove.

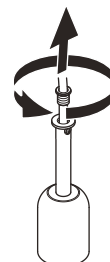

ASSEMBLY

- 4.
- Feed the electrical cord through the hole inside the Crescent shade until the washer sits against the inside face of the shade.
 - Feed the electrical cord through the end nut and screw the end nut back into the pendant set ensuring it is fixed tightly.

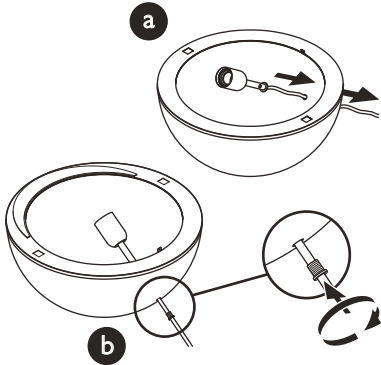

- 5.
- First remove internal packaging from inside shade. Then fit supplied bulb into lamp holder. The supplied bulb is recommended by Lee Broom for correct brightness and colour temperature. Alternative bulbs are available.

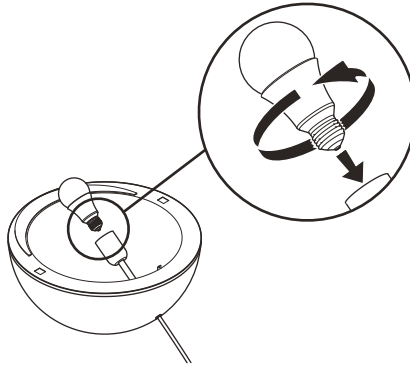

- 6.
- Position the two halves flush together simultaneously locating the tab and two hooks into the square holes.
 - Slide the half with the two hooks down so that hooks latch into position.

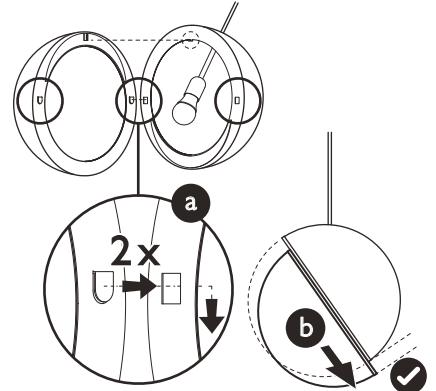

- 7.
- Insert and screw grub screw all the way back into the top of the shade to ensure both halves are fixed securely.

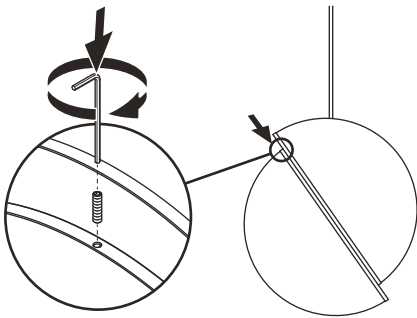

- 8.
- Separate back plate from the canopy cover by unscrewing the end nut.

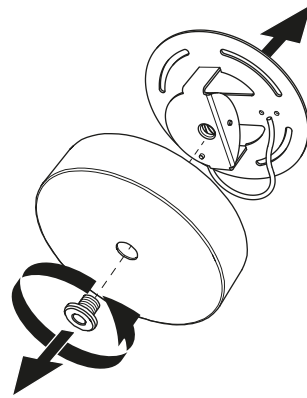

- 9.
- Mount the back plate onto standard 4" octagonal junction box. If you do not have one in the desired position, get your electrician to install one. Fixings not supplied. Suitable junction box bolts should be used.

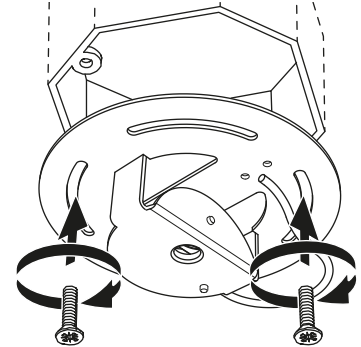

- 10.
- Thread the electrical cord through the end nut and canopy cover.

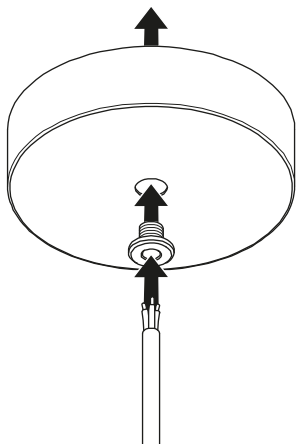

- 11.
- Loosen the two screws on the cord restraint.
 - Thread the electrical cord through the cord restraint.
 - Tighten screws on cord restraint at desired length.

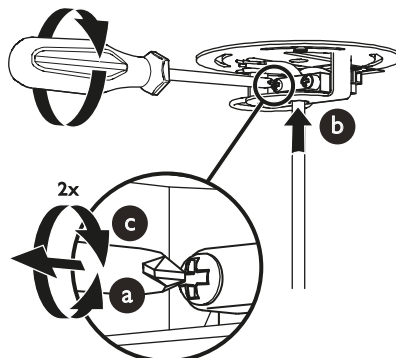

- 12.
- Make electrical connections to the correct wires using the wire nuts provided. This product must be grounded.
 - Attach the canopy cover by screwing the end nut into the back plate.

