

FLOS

F7402009 White

Taraxacum 2

Designed by Achille and Pier Giacomo Castiglioni, 1960



Halogen - 100W

Suspension lamp providing diffused light. White powder coated internal steel structure sprayed with a unique cocoon resin to create the diffuser which is then protected by a transparent sprayed on finish.

Are you a professional and your project needs consulting and support?

[BOOK AN APPOINTMENT](#)

Main specifications

EAN	8059607023518
Mounting	Suspension
Environments	Indoor dry location
Light source type	Bulb
Light sources included	No
Lamp category	Halogen
Lamp holders	E27
Icos	HSGS
Number of lamps	1
Power (W)	100

Physical

Colour	White
Length (mm)	570
Cord colour	White
Cord length (mm)	2700
Canopy colour	White
Canopy length/diameter (mm)	146
Canopy height (mm)	36
Net weight (kg)	2.8
Package height (mm)	710
Package width (mm)	910
Package length (mm)	920
Package volume (m3)	0.59
IP internal	20

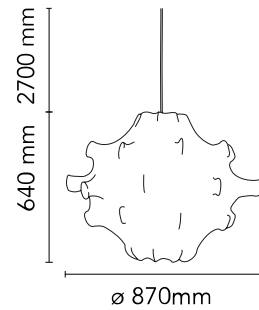

Download

[Mounting instructions](#) PDF

[Mounting instructions](#) PDF

Photometric Files

[LDT / IES](#) LDT

Technical Drawings

[2D](#) ZIP

[3D](#) ZIP



Schematic light drawing

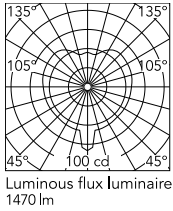

Photometric

Lighting type	Total
Light distribution	Asymmetric
Extreme cut off	No

Electrical

Insulation class	I
Frequency (Hz)	50/60
Main voltage (Vac)	220-250
Dimmable	Yes
Dimming interface	Remote Dimmable (Dimmer Not Included)
Batteries inside	No

Bulbs



NOT INCLUDED

RF32288

LED Lamp E27 15W 2700K T38



NOT INCLUDED

RF32289

LED Lamp E27 15W 3000K T38

Spare Parts

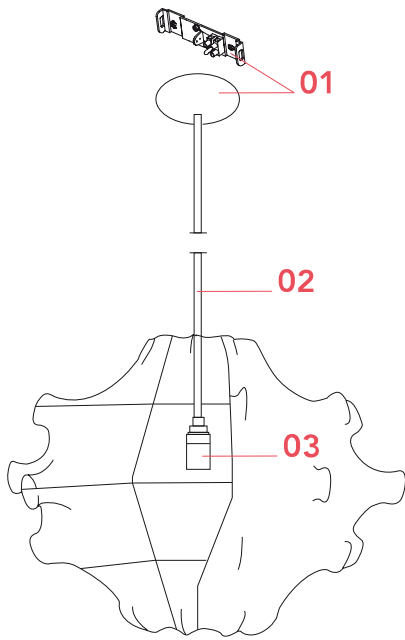

- | | | |
|-----|-------------------------|-----------|
| 01. | White rose assembly | RA3690209 |
| 02. | Wiring 2x0,75 3,2m | RF32763 |
| 03. | Electrical assembly set | RF9800200 |



RA3690209

White rose assembly



RF32763

Wiring 2x0,75 3,2m



RF9800200

Electrical assembly set