

LAMPE GRAS  
N°217

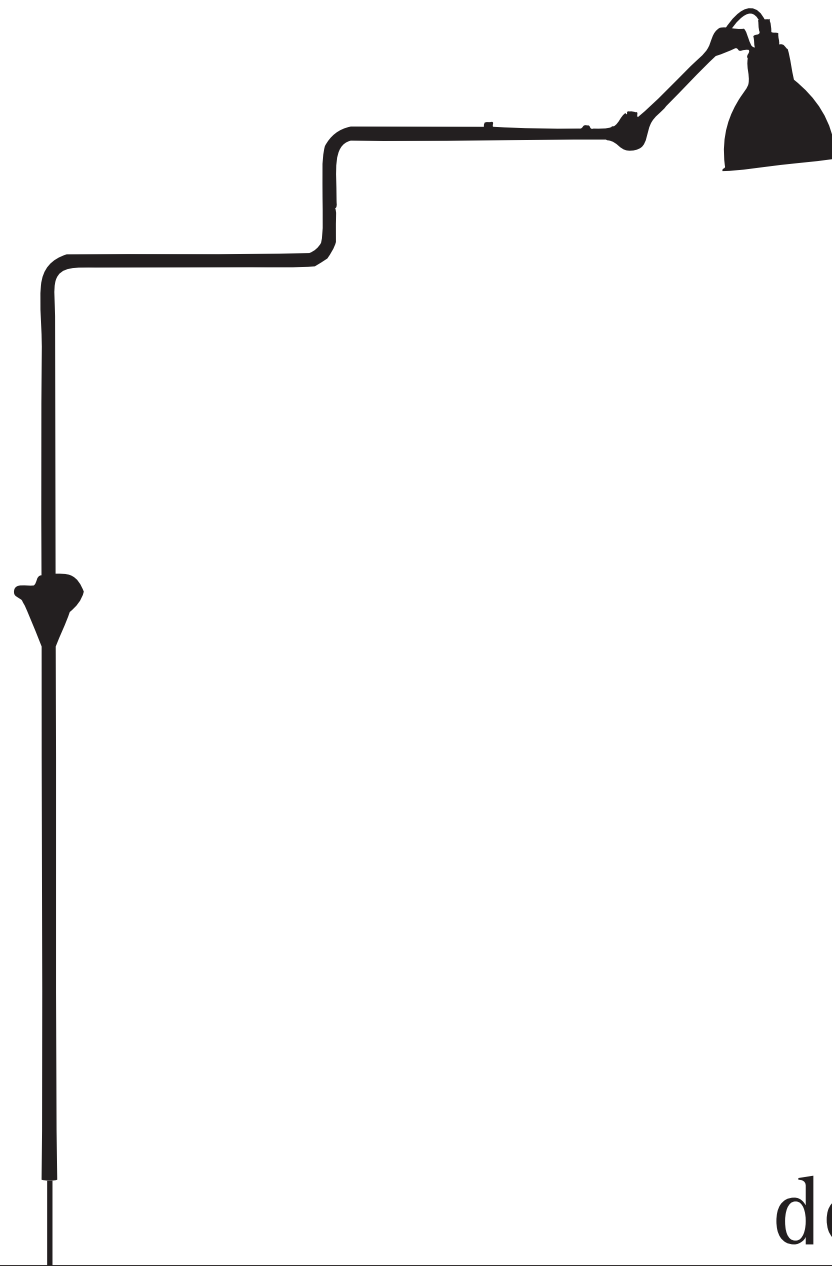

dcw.



WARNING / ATTENTION

If you are unsure about your wiring, please consult a qualified electrician.  
The damaged cables should be changed by manufacturer or distributor or qualified electrician.  
En cas de doute sur le branchement de cette lampe, veuillez consulter un électricien qualifié.  
Tout câble électrique endommagé doit être remplacé par un professionnel qualifié.

1

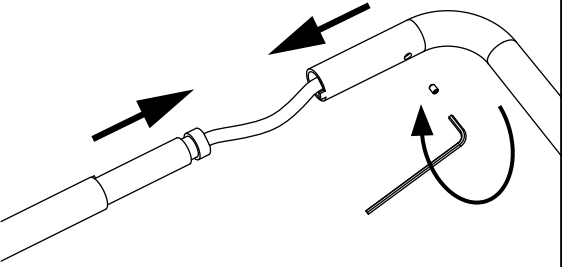

2

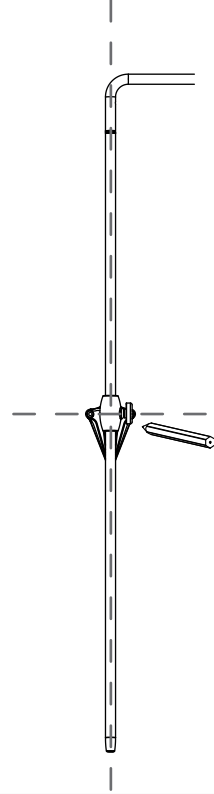

5

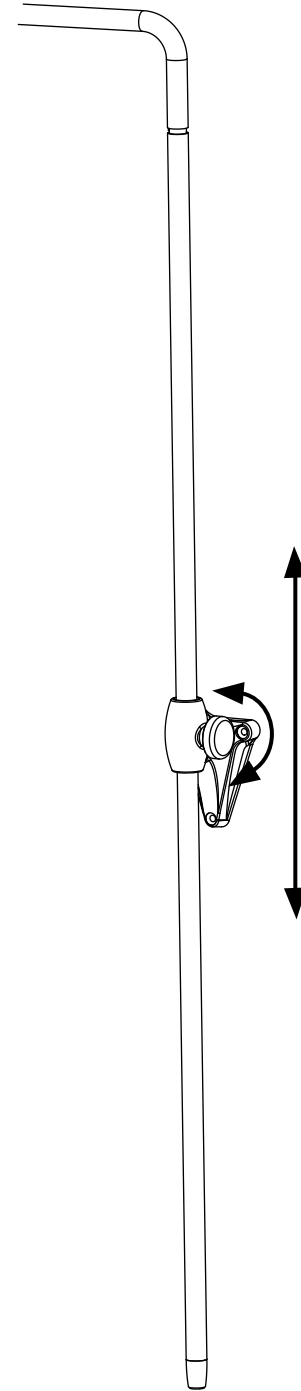

3

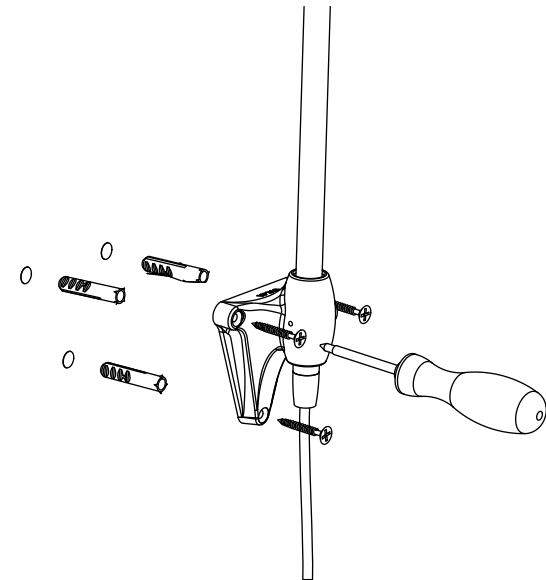

4

