

BABU

Massimiliano Raggi



TEXTILE SMALL



TRIBAL MEDIUM



TEXTILE LARGE



Babu è una collezione da esterni IP65 pensata per sorprendere tracciando un segno luminoso nello spazio. Realizzata attraverso la tecnologia innovativa della stampa digitale tridimensionale su tessuti per esterno che regala profondità e crea interessanti giochi ottici. Disponibile in tre dimensioni e due varianti di trame: Babu Textile con passamaneria in velluto outdoor, nelle colorazioni Arancio, Blu avio e Senape e Babu Tribal con i suoi disegni geometrici sovrapposti. La base è realizzata in acciaio con trattamento di cataforesi laccato effetto champagne (pertanto adatta per l'utilizzo navale). Le lampade sono fornite con connettore IP68. Su richiesta è disponibile l'ancoraggio a terra a seconda del tipo di superficie a cui si vuole fissare.

Babu is an IP65 outdoor collection designed to surprise by tracing a luminous sign in the space. It is made using the innovative technology of three-dimensional digital printing on outdoor fabrics, which gives depth and creates interesting optical games. Available in three sizes and two variations of textures: Babu TEXTILE with outdoor velvet trimmings, in the colours Orange, Blue and Mustard, and Babu TRIBAL with its overlapping geometric designs. The base is made of champagne painted steel with the cathoresis treatment (Marine Grade). The lamps are supplied with an IP68 connector. On request, ground anchoring is available depending on the type of surface to be fixed upon.

SPECIFICHE PRODOTTO / PRODUCT SPECIFICS

p2

BABU SMALL
BABU MEDIUM
BABU LARGE

p4

p5

p6

ANCORAGGIO A PAVIMENTO / FLOOR ANCHORING
ANCORAGGIO A TERRENO / GROUND ANCHORING
ANCORAGGIO A CEMENTO / CEMENT ANCHORING

p7

p8

p9



STRUTTURA / FRAME



Acciaio laccato effetto champagne,
trattamento cataforesi Marine Grade
*Champagne painted steel,
Marine Grade with cataphoresis
treatment*

PARALUME / SHADE



Stampa TEXTILE digitale 3D
su tessuto
*3D digital TEXTILE printing
on fabric*



Passamaneria in velluto outdoor
senape
*"Mustard colour" velvet trim -
for outdoor use*



Passamaneria in velluto
outdoor arancio
*"Orange colour" velvet trim -
for outdoor use*



Passamaneria in velluto outdoor
blu avio
*"Aviation blue colour" velvet trim -
for outdoor use*



Stampa TRIBAL digitale 3D
su tessuto
*3D digital TRIBAL printing
on fabric*

NOTE:

1. Fornita solo con connettore IP68. In caso di collegamento con spina, il grado di protezione passa da IP65 a IP44.
2. Rimuovere i diffusori per la pulizia interna e dei diffusori stessi della lampada.
3. Utilizzare un panno umido per pulire la struttura interna.

NOTES:

1. Supplied only with IP68 connector. In case of connection with a plug, the degree of protection changes from IP65 to IP44.
2. Remove the shades for cleaning the interior and the diffusers themselves.
3. Use a dry cloth to clean the frame of the lamp.

ANCORAGGIO AL SUOLO / GROUND ANCHORING

Ancoraggio a pavimento
Floor anchoring



Ancoraggio a terreno
Ground anchoring



Ancoraggio a cemento
Cement anchoring

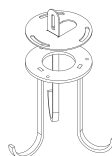



CAVO / CABLE

Cavo nero
Connettore IP68 per esterni
*Black cable
IP68 outdoor connector*

L: 200 cm
L: 78.7"



FRONTE LUMINOSA / LIGHT SOURCE



Strip LED
IP65



SMALL

1 X 17W
Lumen: 1.820
3.000 K; CRI: >90

MEDIUM

1 X 24W
Lumen: 2.600
3.000 K; CRI: >90

LARGE

1 X 34W
Lumen: 3.640
3.000 K; CRI: >90



USA



Strip LED
IP65

SMALL

1 X 17W
Lumen: 1.820
3.000 K; CRI: >90

MEDIUM

1 X 24W
Lumen: 2.600
3.000 K; CRI: >90

LARGE

1 X 34W
Lumen: 3.640
3.000 K; CRI: >90

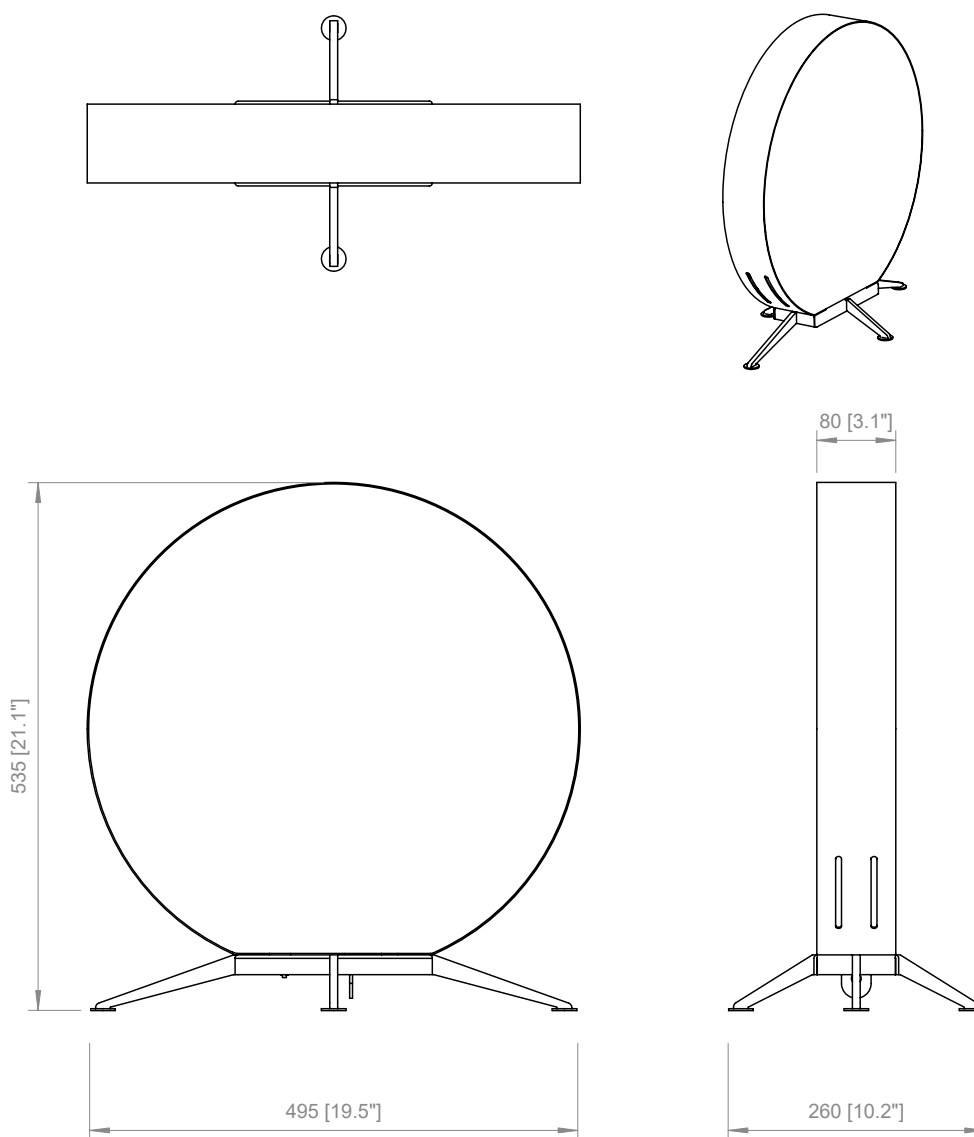

PRODOTTO / PRODUCT

PESO / WEIGHT
6 kg / 13.2 lbs

BOX 1

L: 62 cm / 24.4"
W: 62 cm / 24.4"
H: 15 cm / 5.9"

PESO / WEIGHT
5,5 kg / 12.1 lbs

BOX 2

L: 59 cm / 23.2"
W: 55 cm / 21.6"
H: 4 cm / 1.6"

PESO / WEIGHT
1,5 kg / 3.3 lbs

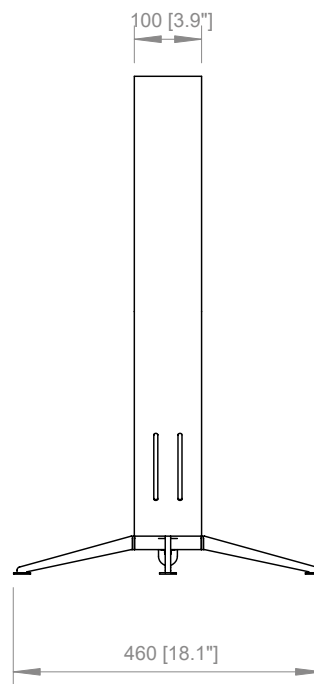
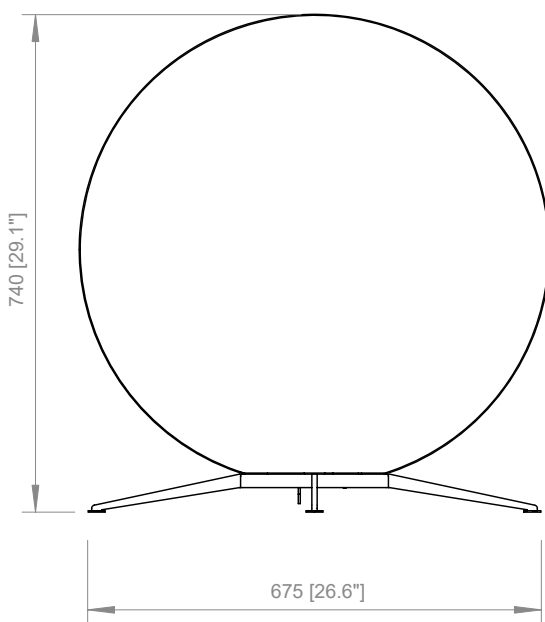
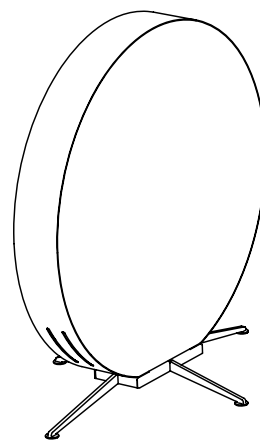
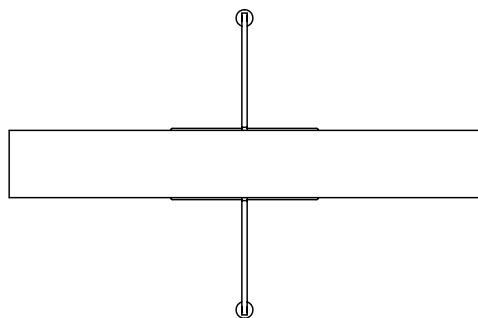

PRODOTTO / PRODUCT

PESO / WEIGHT
10 kg / 22 lbs

BOX 1

L: 84 cm / 31.5"
W: 84 cm / 31.5"
H: 17 cm / 6.3"

PESO / WEIGHT
8,5 kg / 18.7lbs

BOX 2

L: 79 cm / 30.9"
W: 75 cm / 29.3"
H: 4 cm / 1.6"

PESO / WEIGHT
2 kg / 4.4 lbs

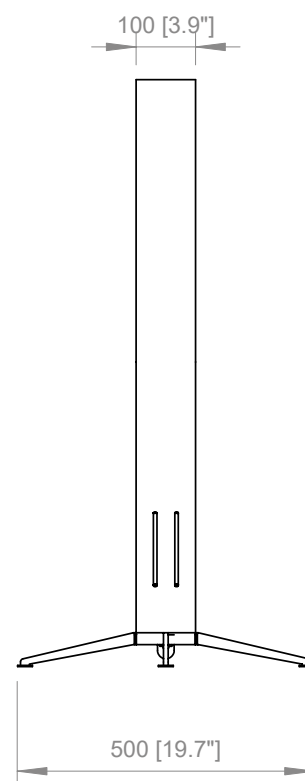
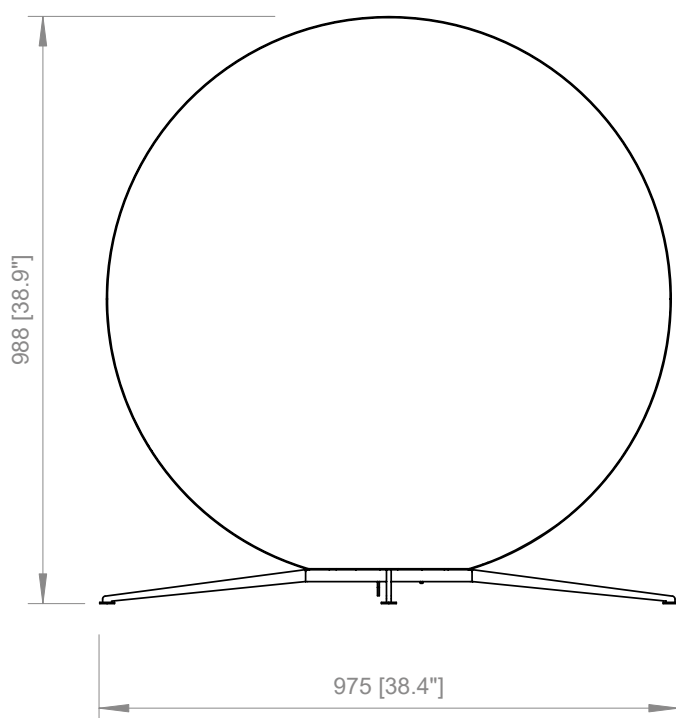
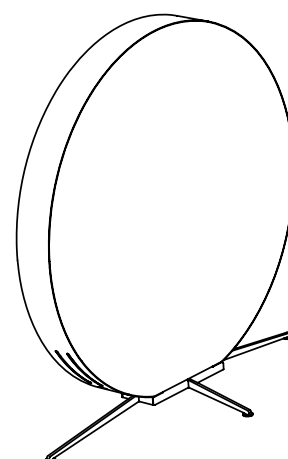
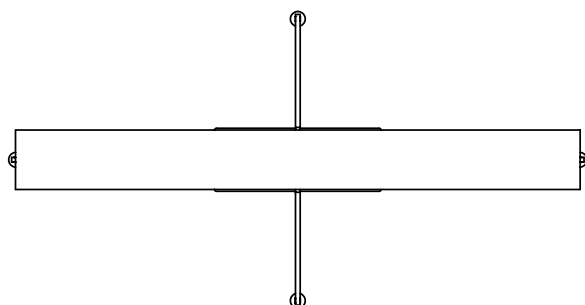

PRODOTTO / PRODUCT

PESO / WEIGHT
12 kg / 26.4 lbs

BOX 1

L: 105 cm / 41.3"
W: 105 cm / 41.3"
H: 17 cm / 6.7"

PESO / WEIGHT
11 kg / 24.2 lbs

BOX 2

L: 104 cm / 40.9"
W: 100 cm / 39.4"
H: 5 cm / 1.9"

PESO / WEIGHT
2.5 kg / 5.5 lbs

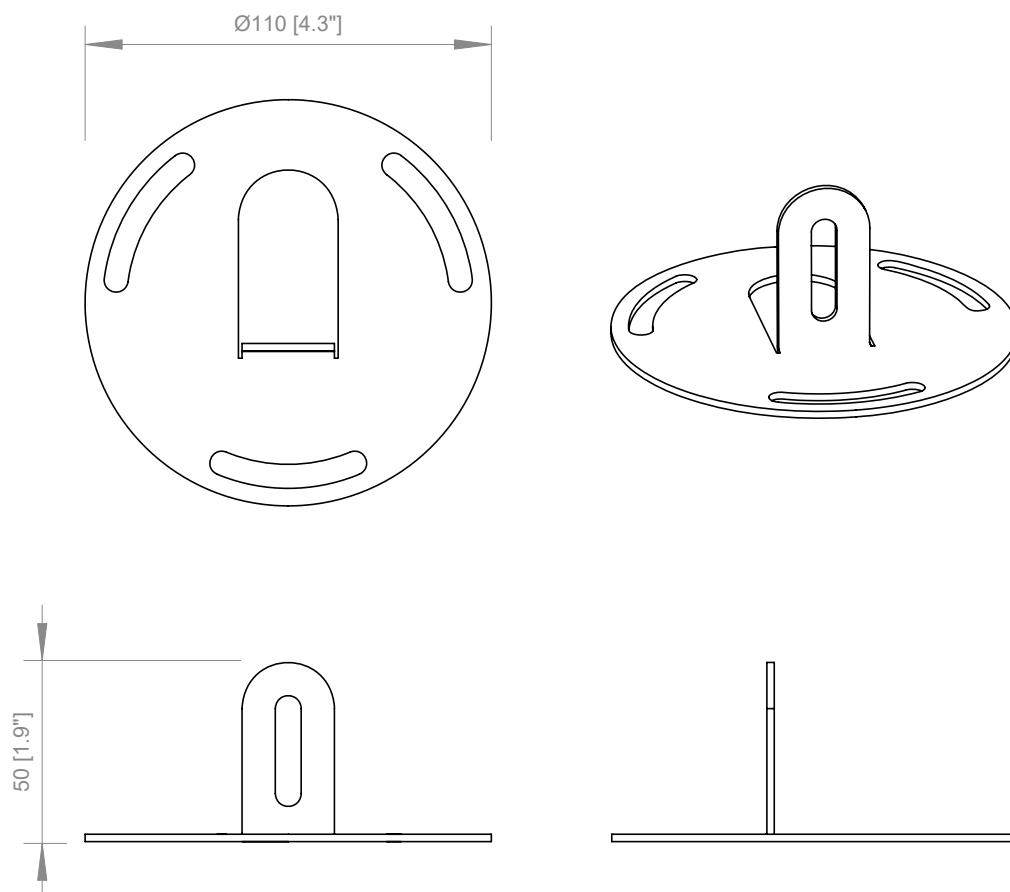

PRODOTTO / PRODUCT

PESO / WEIGHT
0,5 kg / 1.1 lbs

BOX 1

L: 16 cm / 6.3"
W: 16 cm / 6.3"
H: 12 cm / 4.7"

PESO / WEIGHT
0,5 kg / 1.1 lbs

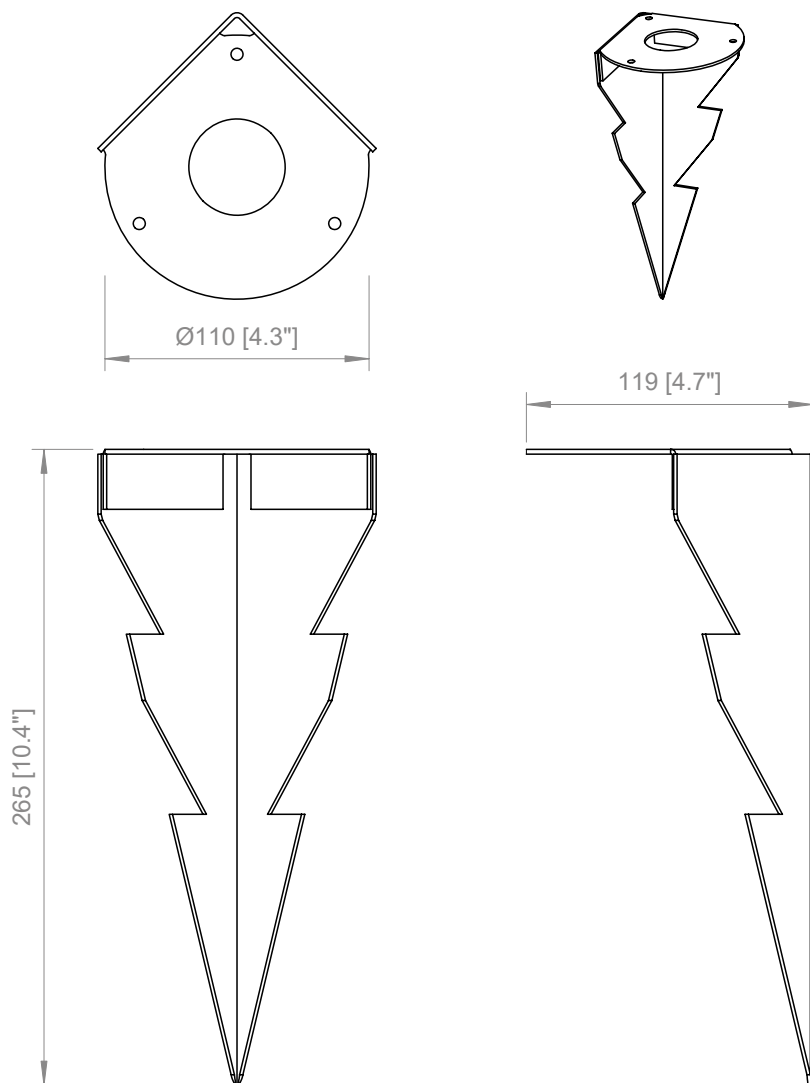

PRODOTTO / PRODUCT

PESO / WEIGHT
4,3 kg / 11 lbs

BOX 1

L: 42 cm / 16.5"
W: 18 cm / 7.1"
H: 18 cm / 7.1"

PESO / WEIGHT
1 kg / 2.2 lbs

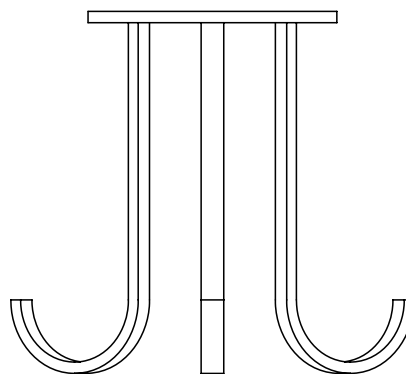
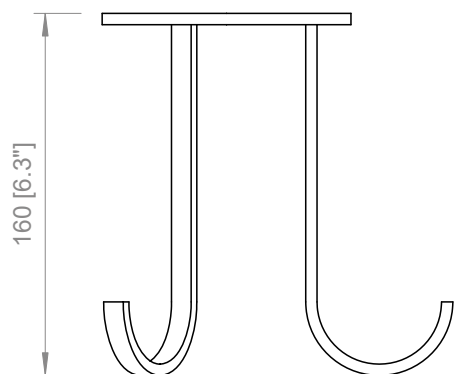
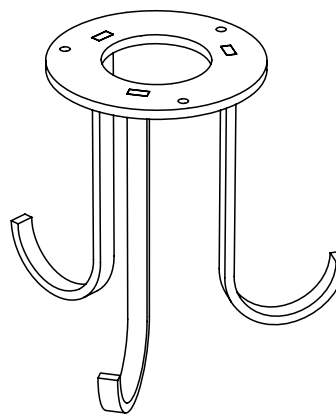
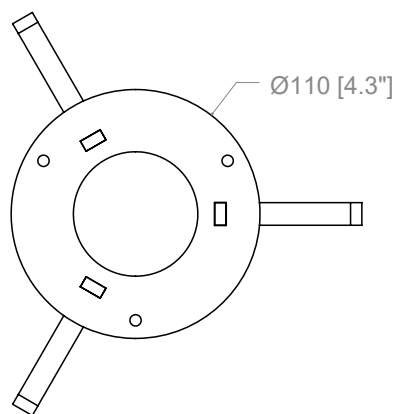



Copyright and/or design rights subsist in this drawing. No part of this drawing may be reproduced in any material form (including photocopying or storing in any medium electronic means, whether or not intentionally and whether or not as part or a larger publication) without the express permission of the copyright owner, Contardi Lighting S.r.l.. Further and without prejudice to the above, this drawing and all information relating thereto is confidential, and shall not be communicated to a third party without the consent of Contardi lighting srl. Contardi lighting srl asserts all rights to be identified as the author of the work and otherwise.

WARNING: The doing of any unauthorised act in relation to a copyright work may result in both a civil claim for damages and criminal prosecution.

CONTARDI LIGHTING Srl

ITALY HEADQUARTERS

www.contardi-italia.com / sales@contardi-italia.it

CONTARDI USA Inc

USA BRANCH

www.contardi-usa.com / sales@contardi-usa.com

