

INSTALLATION GUIDE

Pendants

Thoughtful lighting, responsibly designed in London.

Thank you for making the switch to Tala.
Discover the full Tala family at us.tala.co.uk

BEFORE STARTING

We recommend the installation of our Canopy and Pendants is performed by a qualified electrician. Please read the instructions thoroughly before commencing work and keep them for future reference. Please take extreme care when carrying out these instructions.

IMPORTANT

This light fitting must be connected to the earth supply. If your lighting circuit does not have an earth, ask a qualified electrician to provide an earth facility. This light fitting is suitable for indoor use only. This fitting operates on 120V mains voltage. For a list of recommended dimmers to pair with this light fitting, please visit our website.

WARNING

You must switch off electricity supply at the mains during installation and maintenance. We strongly recommend that you withdraw the fuse or switch off the circuit breaker whilst work is in progress. Do not only turn off the wall switch. All fittings must be installed in accordance with current NFPA 70, National Electrical Code (NEC).

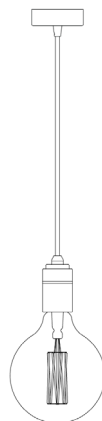

OAK-KP-02-EU
WALT-KP-02-EU
BRAS-PD-02-EU
GRAP-PD-02-EU

OAK & WALNUT PENDANT COMPONENTS

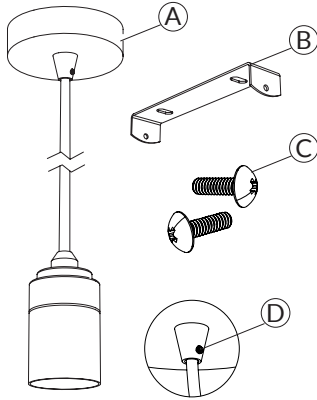

(A) x1 Ceiling Rose with Cable and Pendant

(B) x1 Ceiling Bracket

(C) x2 Bolts M4

(D) x1 Grub/Set Screw

RECOMMENDED EQUIPMENT

- Small electrical screwdriver
- Cross head screwdriver
- Wire strippers
- Insulation tape
- x2 Wall Screws
- x2 Wall Plugs

Further equipment may be required for making holes in your ceiling.

STEP 1

Attach component (B) to your ceiling using screws and plug. Always choose screws and plugs that are appropriate for the material.

MOUNTING SCREWS NOT INCLUDED

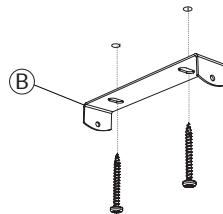

STEP 2

Adjust the cord to your desired length. Using a flat head screw driver, tighten 'grub/set screw' (D) This will secure the cable in place. Maintain all double insulation.

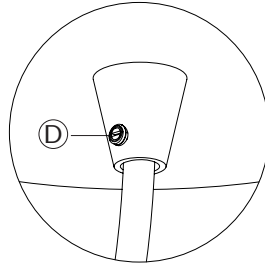

STEP 3

First identify your household wiring using IEE Wiring regulations. Attach the pendant wiring to your household supply as seen below. Use an appropriate junction box.

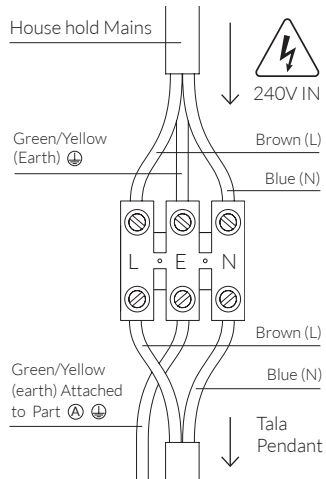

STEP 4

Fasten part (A) to part (B) using the bolts provided (C)

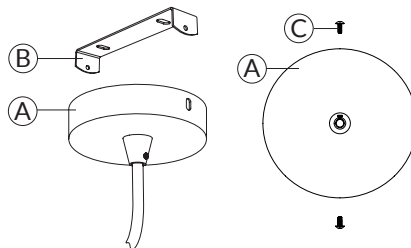

CARE AND CLEANING

We recommend cleaning with a soft dry cloth. Do not use abrasive materials as these will damage the finish.

WARRANTY AND AFTER-CARE

This product has a one-year warranty. Within this time we will replace any fixtures that have functional defects. Please report any faults by emailing customerservice@tala.co.uk



Pendant Layouts

DISTANCE BETWEEN PENDANTS

When arranging pendant drops, plan the location of each pendant on the ceiling.

Recommended minimum distance between the centre of each ceiling rose **(A)** is **180mm (7in)**.

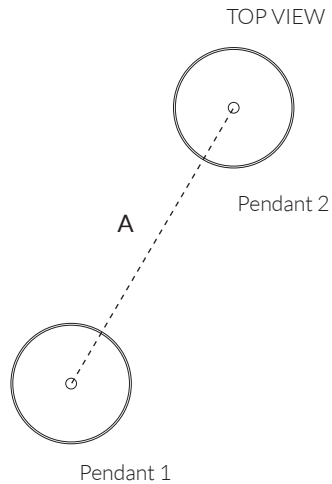

ADJUSTING THE CORD

To adjust the cord to your desired length, using a flat head screw driver, loosen the grub/set screw **(1)** and push the cable up into the ceiling plate.

Secure the cable in place by re-tightening the grub screw. Maintain all double insulation.

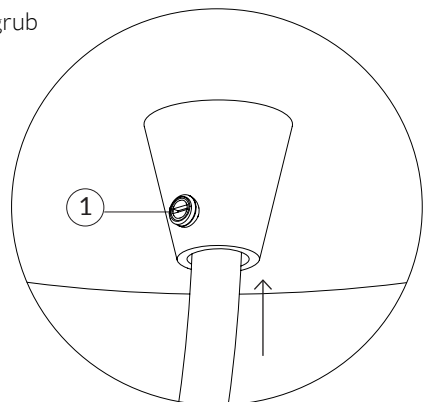

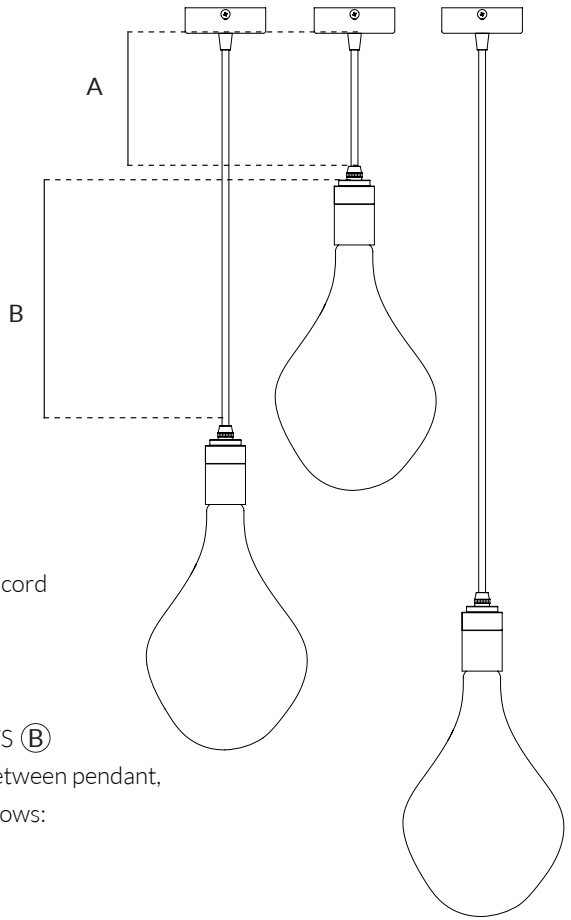

MINIMUM CORD LENGTH (A)

For all bulbs shortest recommended cord length is **350mm (14in)**

DISTANCE BETWEEN PENDANTS (B)

Recommended minimum distance between pendant, dependant on bulb style, are as follows:

Voronoi I - **150mm (6in)**

Voronoi II - **200mm (8in)**

Voronoi III - **350mm (14in)**

Basalt - **100mm (4in)**

All other bulbs - **100mm (4in)**

PENDANTS - RECOMMENDED CABLE LENGTHS

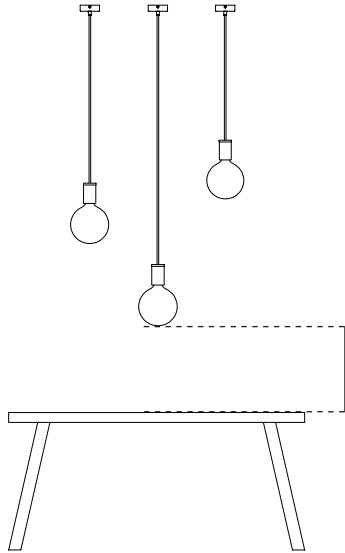

Minimum Distance
700mm (28in)

SCENARIO 1 - OVER COFFEE OR DINING TABLES

Where height is required for
seated tasks

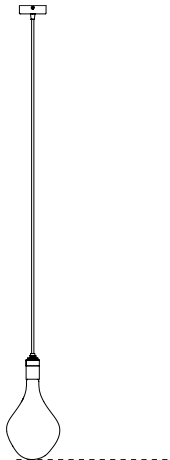

Minimum Distance
500mm (19in)

SCENARIO 2- OVER SIDE OR BEDSIDE TABLE

Where height is only required
for storage.

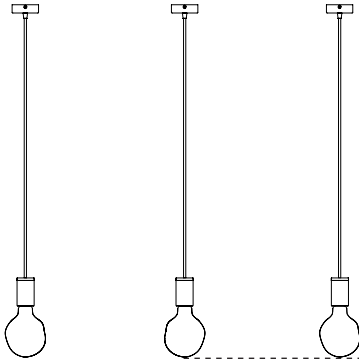

SCENARIO 3 - OVER KITCHEN ISLAND OR BAR

Where height is required for standing tasks.

Minimum Distance
800mm (32in)

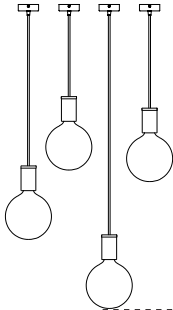
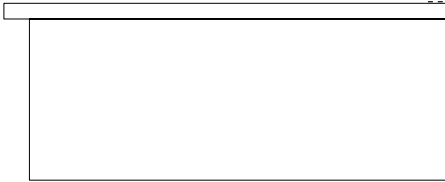

SCENARIO 4 - OVER A STAIRWELL OR WALKWAY

Where height is required for walking underneath.

Minimum Distance
2.2m (7Ft)

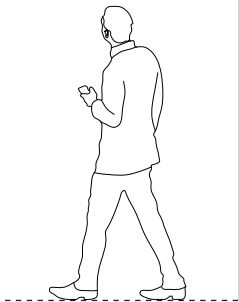

Join the Community

Instagram: @tala | Facebook: talaHQ | Pinterest: TalaLED | Tag: lighttoliveby
Tala Studios, 25B Vyner Street, London E2 9DG | +44 20 3026 3246 | hello@tala.co.uk