

LEE BROOM

CRYSTAL TUBE LIGHT

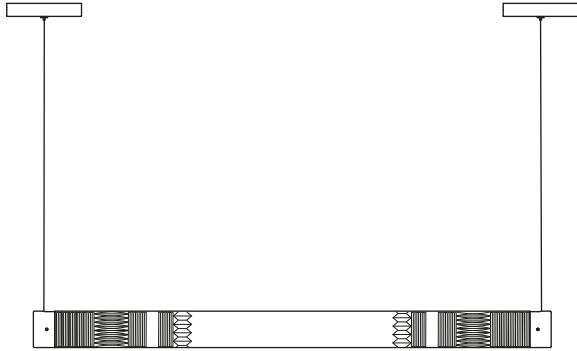

CONTENTS



1 x
Crystal Tube Light

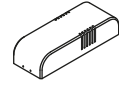

1 x
LED Driver

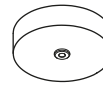

1 x
Canopy A

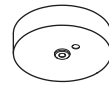

1 x
Canopy B

ATTENTION! BEFORE YOU START

- Crystal Tube Light must be installed by a qualified electrician.
- Ensure power supply is disconnected prior to installation.
- This product is for interior use only and should be installed in a dry environment only.
- Please read the instructions carefully before you commence install and retain them for future reference.

ASSEMBLY - please see associated diagrams overleaf

- TERMINATE ALL MAINS WIRES BEFORE INSTALLATION
 - IMPORTANT! LED DRIVER MUST BE USED, DO NOT WIRE THIS PRODUCT DIRECT TO MAINS SUPPLY.
1. Create one suitable hole in the ceiling positioned exactly where the electrical power supply is located for the Crystal Tube Light. We recommend a $\varnothing 3$ in circular hole or a $2\frac{1}{2}$ in x 2 in rectangular hole. The hole in the ceiling is to house the LED Driver. Ensure the hole is big enough to fit the driver but not so big that you cannot securely fix the ceiling canopy.
 2. Separate the back plate from canopy A & B by unscrewing the end nut. Please note that canopy A has an extra hole for the power cable.
 3. Thread the power cable through the assigned hole on canopy A, cord restraint and through one of the back plates.
 4. Connect the Crystal Tube Light power cable to the output connections on the LED Driver. Please note the white labeled cable connects to the positive (red) output and the clear cable connects to the negative (black) output.
 5. Connect the mains live and neutral wires to the correct input connections on the LED Driver.
 6. Hide the driver in the ceiling.

7. Ensure the mains earth wire is long enough to connect to the earth tag in the base plate. This can be extended if necessary using a wire and connector block.
8. Ensure the mains earth cable is accessible through the hole in the ceiling so the ceiling canopy can be earthed.
9. Mount the first back plate over the hole created to house the LED Driver. Position the second back plate 80.5cm / $31\frac{3}{4}$ inch from the first back plate (measure from inside edge). Always use the appropriate fixings for the ceiling material you are fixing to.
10. Thread the tension wires through the end nuts and through canopy A & B.
11. Lift the Crystal Tube into position and thread the tension wires into the back plate and tension wire grip. Set the tensile wires at the desired drop height. Please note this will require two people.
12. Restrain the power cable with the cord restraint provided at the desired drop height.
13. Connect the mains earth wire to the earth tag on the base plate.
14. Attach the canopy cover by threading the end nut into the back plate.

CARE AND CLEANING

- Only clean when Crystal Tube Light is switched off.
- Please allow a suitable cooling period before cleaning.
- Only use a non-abrasive, soft, dry cloth when cleaning Crystal Tube.

For more information please contact:

US & Canada Inquiries: +1 212 804 8477 - 34 Greene Street, New York, NY 10013 - sales@leebroom.com

UK & Global Inquiries: +44 207 820 0742 - 95 Rivington Street, London, EC2A 3AY - info@leebroom.com

WWW.LEEBROOM.COM



ASSEMBLY

1.

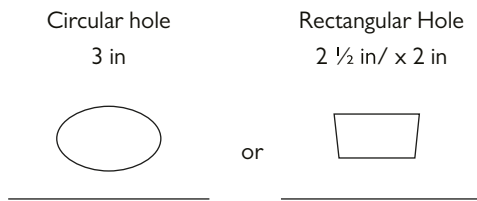

2.

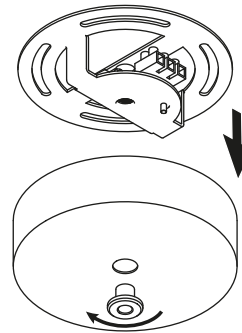

3.

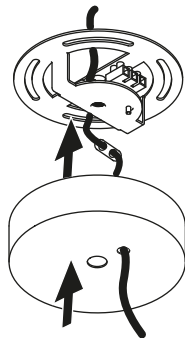

4.

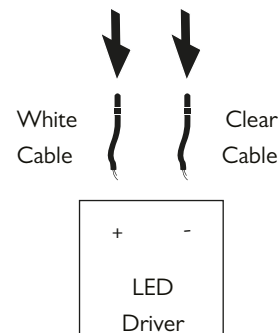

5.

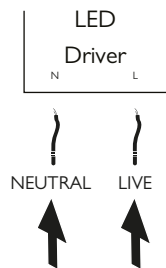

6.

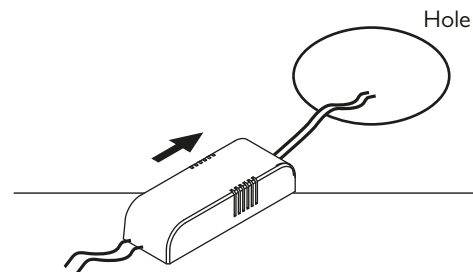

7.

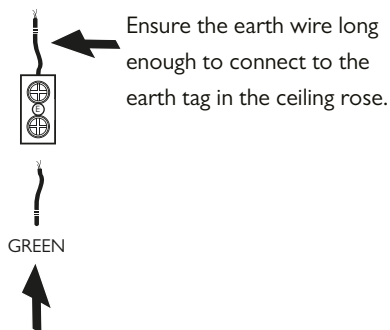

8.

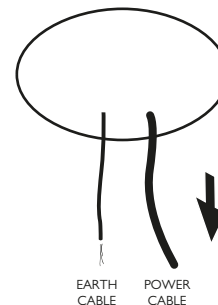

For more information please contact:

US & Canada Inquiries: +1 212 804 8477 - 34 Greene Street, New York, NY 10013 - sales@leebroom.com

UK & Global Inquiries: +44 207 820 0742 - 95 Rivington Street, London, EC2A 3AY - info@leebroom.com

WWW.LEEBROOM.COM

ASSEMBLY

9.

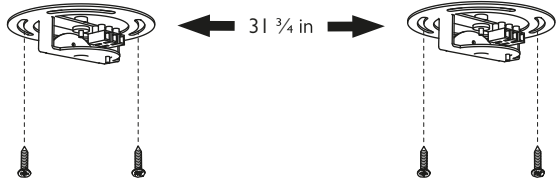
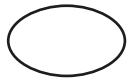

10.

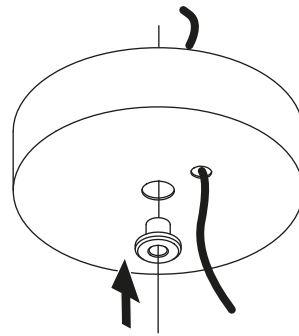

11.

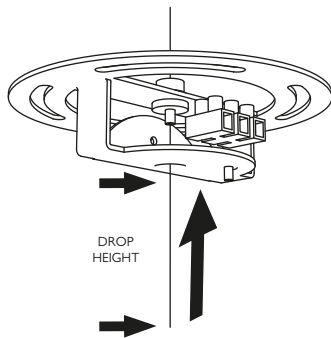

12.

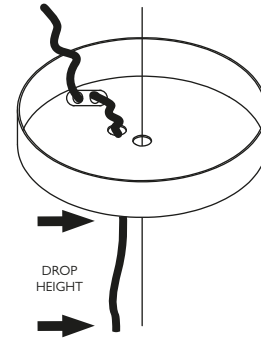

13.

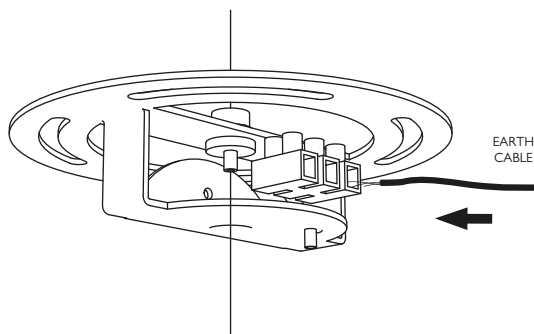

14.

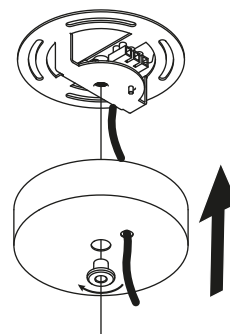

For more information please contact:
US & Canada Inquiries: +1 212 804 8477 - 34 Greene Street, New York, NY 10013 - sales@leebrook.com
UK & Global Inquiries: +44 207 820 0742 - 95 Rivington Street, London, EC2A 3AY - info@leebrook.com
WWW.LEEBROOM.COM

