

LEE BROOM

CAROUSEL

US: CA0110 / CA0111 / CA0112 / CA0113

CONTENTS

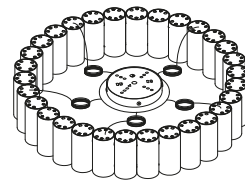
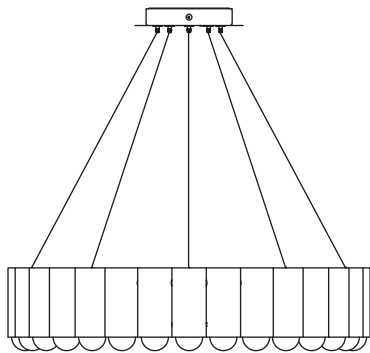

1 x Carousel

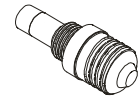

30 x LED Bulb



3 x Wire Nuts



1 x Allen Key



30 x Glass Diffuser Cap

ATTENTION! BEFORE YOU START

For safety please read these instructions carefully before you commence install and retain them for future reference.

- Carousel must be installed by a qualified electrician.
- Install according to latest NEC wiring regulations.
- Minimum of 2 people required for installation.
- Ensure mains power supply is disconnected prior to installation.
- This product is for interior use only and should be installed in a dry environment only.
- Bulbs are supplied.
- When switched on Carousel may become hot.

TECHNICAL

110-130V ~ 60Hz; E26 MAX 30 x 2W LED



For more information, please contact:

US & Canada Inquiries: +1 212 804 8477 - sales@leebroom.com

UK & Global Inquiries: +44 207 820 0742 - info@leebroom.com

BULB REPLACEMENT

- Visit www.leebroom.com to purchase replacement 2W LED bulb.
- Maximum wattage 30 x E26 2W LED, 110-130V.
- To replace bulb:
 - i. Make sure Carousel is switched off and ensure LED bulb has cooled down before handling.
 - ii. Unscrew old bulb from Carousel.
 - iii. Unscrew and remove glass diffuser cap from LED bulb. Ensure to retain cap for reassembly to replacement bulb.
 - iv. Screw new bulb into the glass diffuser cap and replace into Carousel fitting. (As seen in assembly step 8)

RECYCLING ELECTRICAL PRODUCTS

Lee Broom encourages all customers to notice this symbol  and avoid putting any waste electrical goods in domestic waste bins or containers. Please ensure waste electrical goods are disposed of at a suitable facility.

CARE AND CLEANING

- Only clean when Carousel is switched off.
- Please allow a suitable cooling period before cleaning.
- Only use a non-abrasive, soft, dry cloth when cleaning the Carousel.

ASSEMBLY

DISCONNECT ALL MAINS POWER SUPPLY WIRES BEFORE INSTALLATION.

1.

Separate the back plate from the canopy cover by unscrewing the 4 screws using the allen key provided.

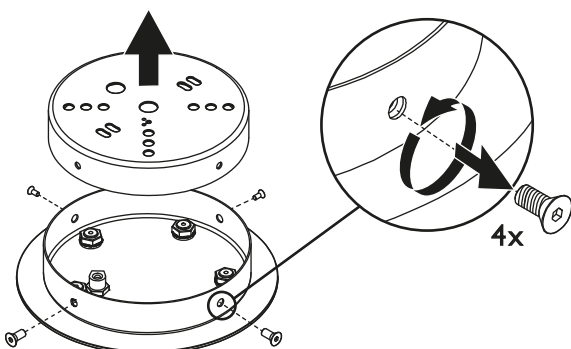

2.

Thread the mains power supply cord through the entry hole of fixing plate and mount the plate onto standard 4" octagonal junction box. If you do not have one in the desired position, get your electrician to install one. Fixings not supplied. Suitable junction box bolts should be used.

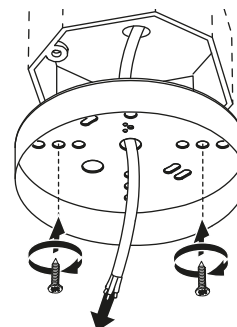

ASSEMBLY

3.

- Unscrew locking nuts on canopy cover to release suspension wires.
- To adjust length shorter, feed wires up through locking nuts.
- To adjust length longer, press down tip of locking nuts whilst pulling the wire away from the canopy.
- Retighten locking nut at desired length.

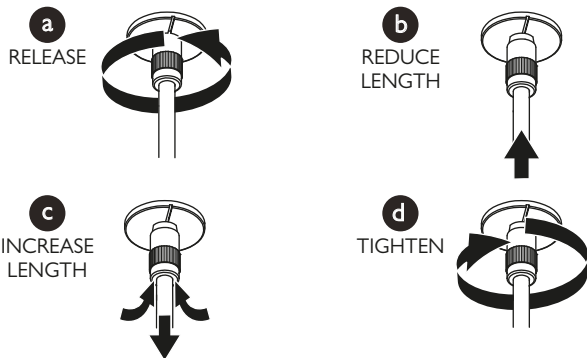

4.

Check drop height is as desired before cutting excess suspension wire 24cm / 9 1/2 in away from the entry hole inside the canopy.

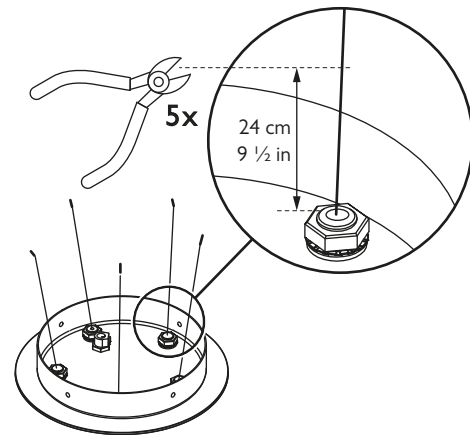

5.

Whilst supporting the full weight of Carousel, make electrical connections to the correct mains power supply wires using the wire nuts provided. This product must be Grounded. NOTE: 1-2 people should support full weight of Carousel whilst one person makes connections at the ceiling.

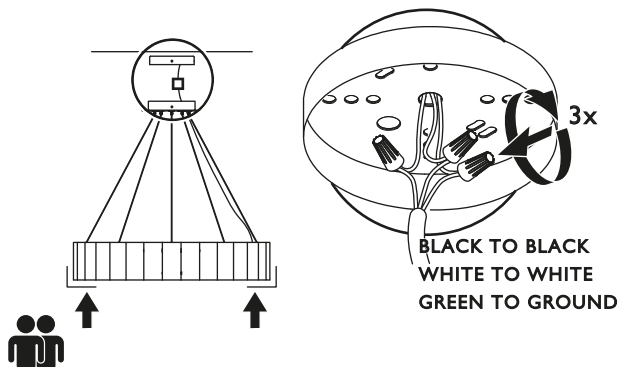

6.

Continue supporting weight of Carousel to reattach the canopy cover to the back plate. Align the screw holes on the side of the canopy cover with the side holes on the back plate. Once aligned, use screws to fix into position.

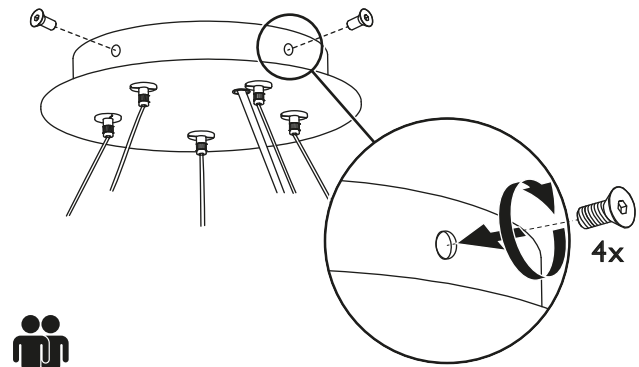

7.

Use method from assembly step 3 to make any necessary minor adjustments to suspension wires to ensure Carousel is hanging level at desired height. Adjust the electrical cord so that there is no excess cord and it runs along the suspension wire.

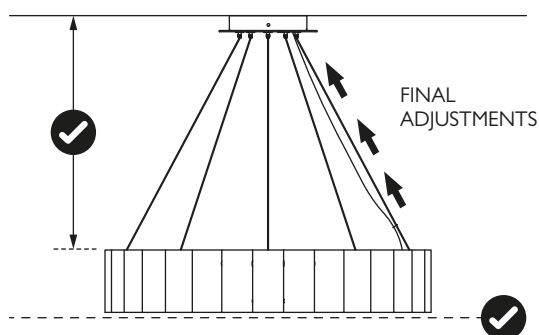

8.

- Screw the E26 LED bulb into the glass diffuser cap.
- Fit bulbs into Carousel, making sure each bulb is screwed in securely.

